

ISOLINE® LOW LINE

Installation



UNIQUE SUB-ROOF SYSTEM FOR
GUARANTEED WATERPROOFING AT A
10° PITCH FOR ALL ROOF TILES.



Onduline®
Lightweight roofing systems

WATERTIGHT SUB-ROOF SYSTEM FOR LOW PITCH ROOFS

ISOLINE® LOW LINE

ISOLINE® LOW LINE is the only sub-roof system in the UK to be BRE tested and BBA Accredited to as low as 10° with a 30-year guarantee.

SUB-ROOF

ISOLINE® LOW LINE

Additional protective layer



ISOLINE® UNDERROOFING
SOLUTION



ISOLINE® GUARANTEED
WATERPROOFING



ONDUTISS® AIR
BREATHABLE MEMBRANES

1. SUMMARY



Eco-responsible



Lightweight



Fast
waterproofing



ISOLINE® LOW LINE

WHAT IS ISOLINE® LOW LINE?

ISOLINE® LOW LINE is a unique waterproofing system for low pitch roofs. Fitted under roof tiles, it is shielded from elements such as wind and rain making it an exceptional long-lasting waterproofing solution.

HOW DOES IT WORK?

ISOLINE® LOW LINE acts as the primary waterproofing layer of a roof, making roof tiles a secondary line of defence. It catches any water that manages to pass through the tiles and drains it down to gutter level.

WHAT APPLICATIONS?

ISOLINE® LOW LINE can be installed in dwellings such as new builds, and extensions. It is also suitable for use on outbuildings, such as garden offices and garages, and any other project with a low pitch requirement.

ISOLINE® LOW LINE can also be used in high pitch roofs in exposed areas where an additional layer of protection is required, and on heritage sites where the existing tiles can be re-used.



INDUSTRIAL FACILITIES

COMMERCIAL BUILDINGS, HOTELS AND RESORTS



HISTORICAL BUILDINGS



COLLECTIVE HOUSING

CONTENTS

1. TECHNICAL CHARACTERISTICS	7
2. UNDER ROOF SOLUTIONS	7
3. INSTALLATION	8
3.1 Fixings	8
3.2 Roof Battens	9
3.3 Battened	9
3.4 Fully Boarded	11
3.5 Warm Roof	12
4. ROOF DETAILS	14
4.1 Ridge and Hip Detail	14
4.2 Wall Abutment	14
4.3 Side Wall Abutment	15
4.4 Valley Detail	15
4.5 Ventilation	16
4.6 Pipe/Vent Penetration	17
4.7 Photovoltaic (PV) Fixings	18
5. ISOLINE® ACCESSORIES	19
6. ROOF MEMBRANES	20
6.1 Condensation Control	20
6.2 Ondutiss Air Membranes	20
7. SUSTAINABILITY COMMITMENT	21
8. GENERAL INFORMATION	23



1. TECHNICAL CHARACTERISTICS

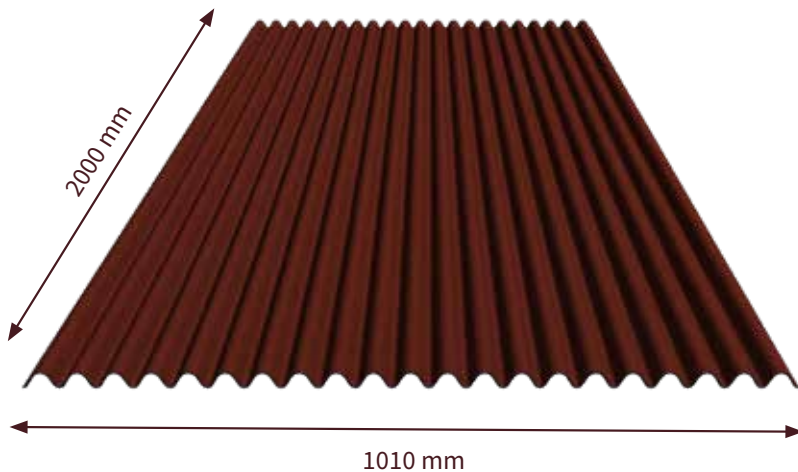

SPECIFICATION		
Length	L	2000 mm
Width	w	1010 mm
Thickness	t	2.4 mm
Height of corrugation	H	24 mm
Pitch of Corrugation	P	48 mm
Gross Surface		2.02 m ²
Weight of product		6.2 kg
Weight per gross surface		3.1 kg/m ²
Corrugations		21
Water impermeability		Pass ¹
Water vapour permeability – EN ISO 12572		> 4000µ

COVERAGE PER SHEET: 1.6M²/SHEET

IMPORTANT NOTE: Coverage is approximate, always allow for tolerance when calculating the amount of sheets.

2. UNDER ROOF SOLUTIONS

BBA accredited for any lapped tile covering down to 10 degrees.

Designed specifically for use on low pitch roofs, this lightweight bituminous underlay sheeting has been rigorously tested and is proven to be a robust solution to waterproof any pitched roof.

With a corrugation height of just 24mm, **ISOLINE® LOW LINE** is fixed below the primary tile or slate roof covering, acting as the primary waterproofing layer of a roof. Thus, making roof tiles a secondary line of defence enabling the pitch of the roof to be much lower than the minimum as recommended by the tile manufacturer.

Not only does this help to meet the demand for maximising living space, as the low pitch means the roof void can be minimised, it also enables traditional tiles to be used in situations where they wouldn't have been able to be

utilised previously, such as extensions or heritage projects, greatly enhancing the aesthetic quality of a property.

Thanks to the corrugations, **ISOLINE® LOW LINE** allows increased ventilation and airflow both above and below the sheet. The tile battens positioned above the corrugations allow moisture to escape which, with the enhanced ventilation, maintains excellent moisture control within the cavity.

The material is also in line with the growing awareness of 'green' issues and the need to offer sustainable solutions, as **ISOLINE® LOW LINE** sheets are made of a minimum 50% recycled cellulose fibres, contain no asbestos and do not release any hazardous substances.



3. INSTALLATION

There are three main types of roof structure ISOLINE® LOW LINE can be installed on:

- 1 - BATTENED
- 2 - FULL DECK
- 3 - WARM ROOF

3.1 FIXINGS

FIXING DETAILS

- Use suitable nails or screws for roofing (not supplied by Onduline).
- Any fixing used must penetrate the support battens or decking by a minimum of 15mm.
- Fixings length may vary depending on the support structure, refer to image.

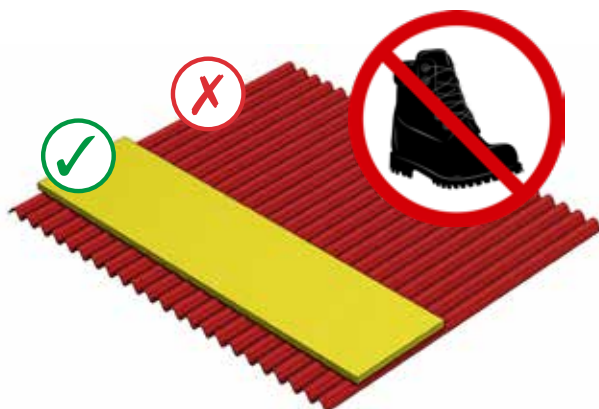
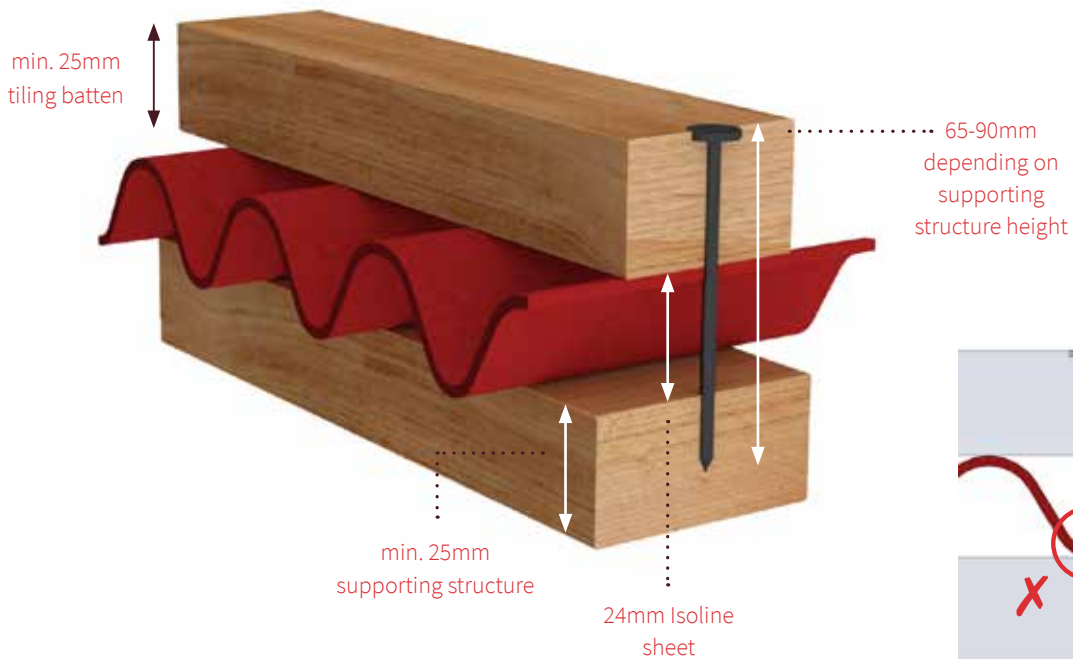

Do not walk directly on the ISOLINE® sheets. Use a timber board (300mm wide or more) to distribute the load.

3.2 BATTENS

BATTEN DETAILS

ISOLINE® LOW LINE can be used with different types of roofing battens depending on your project requirements.

The tiling gauge (distance between battens) should not exceed 300mm. For tiles that require a larger batten gauge, a 'full deck' must be used underneath the ISOLINE sheet.

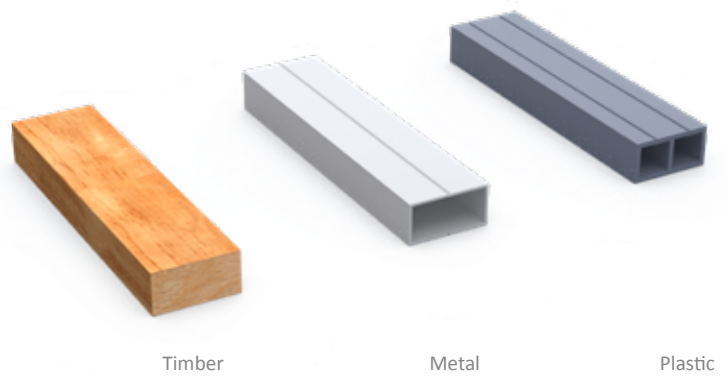

3.3 BATTENED

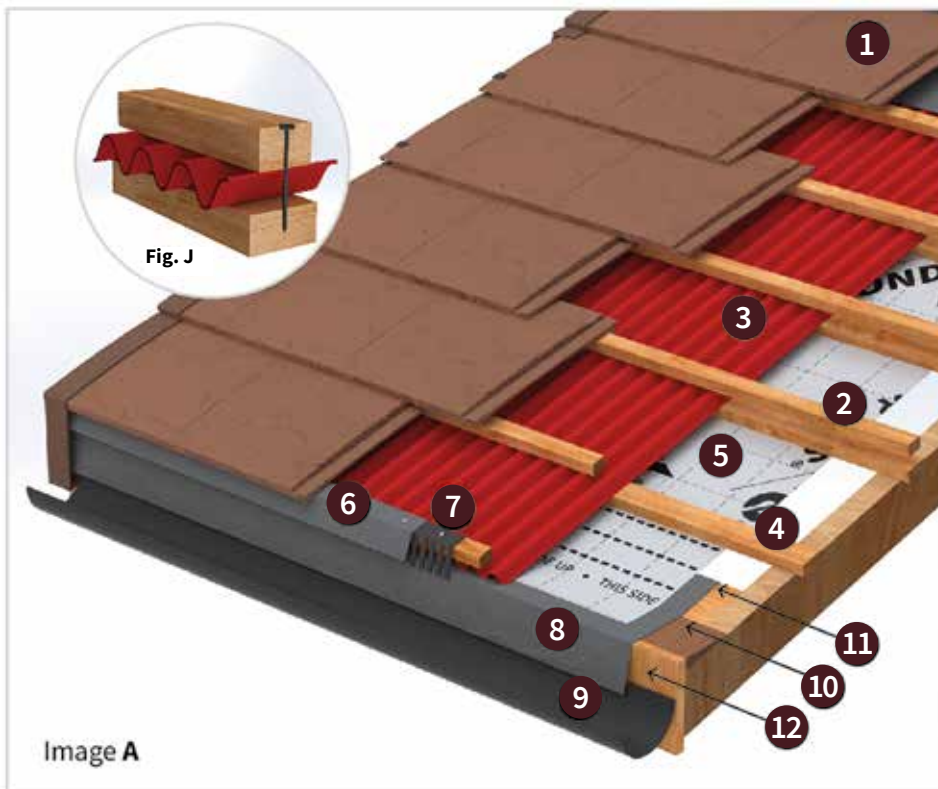

- 1 Roof Tiles
- 2 Tile Batten
- 3 Isoline® Sheet
- 4 Support Batten
- 5 Membrane
- 6 Batten Cloaking Piece
- 7 Ventilator Strip
- 8 Eaves Tray
- 9 Rain Gutter
- 10 Tilting Fillet
- 11 Eaves Tray Support board
- 12 Fascia Board

BATTENED INSTALLATION STEPS

- 1 – Prepare the roof eaves detail to suit roof pitch by incorporating an Eaves Tray Support Board (11), Tilting Fillet (10) and Fascia Board (12) where required.
- 2 – Install Eaves Tray (8). Fix Eaves Tray to the roof structure using nails or screws.
- 3 – Lay **ONDUTISS® AIR** Membrane (5) on top of the rafters (where applicable). A slight drape (maximum 15mm) is recommended between the rafters.

Lay the membrane on top of the Eaves Tray with a minimum overlap of 100mm between the two. Ensure the membrane is not carried on past the top Fascia Board edge (12).

- 4 – Install Support Battens (4) using the ‘tile gauge’ (distance between battens) as per the tile manufacturers recommendation. Support battens should be a minimum of 50mm x 25mm in size and mechanically fixed to the rafters.

For tiles requiring a batten gauge of over 300mm centres a ‘full deck’ must be used.

- 5 – Lay a row of **ISOLINE®** sheets (3) starting at the bottom of the roof. Use the eaves level to align sheets to eaves line.

Each **ISOLINE® LOW LINE** sheet incorporates two horizontally embossed interlocking guide lines. Overlap the sheets horizontally by aligning the embossed lines on the top sheet with the ones on the bottom sheet. This will provide approximately 220mm end lap coverage. For vertical overlaps use two corrugations (approximately 100mm).

Similar to tiling, you must stagger the sheets as you work on the rows upwards. To do this you start with a ‘half-sheet’ (shown in red below) on the second row. This can be done by cutting a sheet vertically in half.

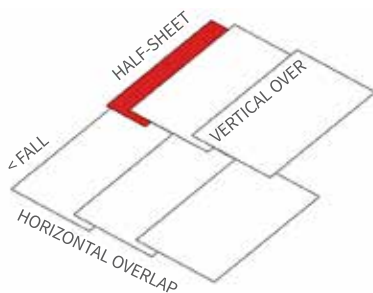

*Note: Do not fix **ISOLINE®** sheets to support battens at this stage.*

- 6 – Lay Tiling Battens (2) on top of **ISOLINE®** sheets and align with Support Battens (4). Use suitable nails or screws to fix the system together as shown on figure ‘J’.

A minimum 65mm fixing is normally used when using 25mm tall tiling battens.

FIXINGS

IMPORTANT NOTE: Fixings must only penetrate the sheets at the apex of the corrugation

A fixing must be used approximately every 350mm centres along the length of the tiling batten.

- 7 – Install Ventilator Strip (7) as shown in the image
A. Install Batten Cloaking Piece (6) and where required cut this horizontally at the front to allow for more air to get into the **ISOLINE® LOW LINE** corrugations.

- 8 – Install tiles as per tile manufacture recommendation.

Note: When installing tiles below the tile manufacturers’ minimum recommended pitch, advice should be sought from the tile manufacturer in regard to fixing specification and/or any other aspects of installation.

For ventilation requirements, see page 20.



3.4 FULL BOARD

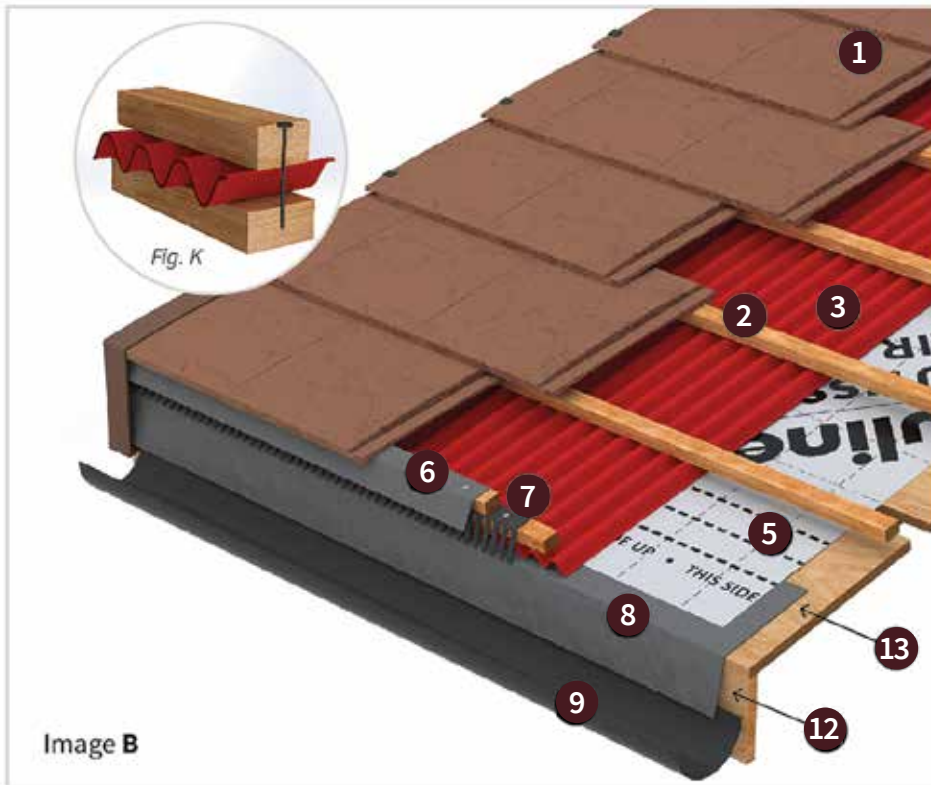

- 1 Roof Tiles
- 2 Tile Batten
- 3 ISOLINE® Sheet
- 5 Membrane
- 6 Batten Cloaking Piece
- 7 Ventilator Strip
- 8 Eaves Tray
- 9 Rain Gutter
- 12 Fascia Board
- 13 Timber Deck

FULL BOARD INSTALLATION STEPS

- 1 - Use timber decking (minimum 18mm) to fully board the roof area.
- 2 - Install Eaves Tray (8). Fix Eaves Tray to the roof structure.
- 3 - Lay **ONDUTISS® AIR** Membrane (5) on the decking area (where applicable). Lay the membrane on top of the Eaves Tray with a minimum overlap of 100mm between the two. Ensure the membrane is not carried on past the top Fascia Board edge (12).
- 4 - Lay a row of **ISOLINE®** sheets (3) starting at the bottom of the roof. Use the eaves level to align sheets to eaves line. Each **ISOLINE® LOW LINE** sheet incorporates two horizontally embossed interlocking guide lines.

Overlap the sheets horizontally by aligning the embossed lines on the top sheet with the ones on the bottom sheet. This will provide approximately 220mm of end lap coverage. For vertical overlaps use two corrugations (approximately 100mm).

Similar to tiling, you must stagger the sheets as you work on the rows upwards. To do this you start with a 'half-sheet' (shown in red below) for the second row. This can be done by cutting a sheet vertically in half.

Do not fix **ISOLINE®** sheets to support battens at this stage.

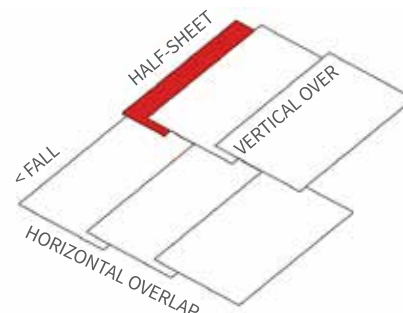

5 - Lay Tiling Battens (2) on top of **ISOLINE® LOW LINE** sheets using the tiling gauge specified by the tile manufacturer. Use suitable nails or screws to fix the system together as shown on figure 'K'.

Fixings must only penetrate the sheets at the apex of the corrugation.

FIXINGS

IMPORTANT NOTE: A fixing must be used approximately every 350mm centred along the length of the tiling batten.

Note: Nails are required to be 'smooth shank' type with a minimum head diameter of 3.5mm. Screws or a nail gun may be used instead providing they offer the same or exceed the fixing strength of nails. Any fixing used must penetrate the support battens or decking by a minimum of 15mm.

6 - Install Batten Cloaking Piece (6) and Ventilator Strip (7) as shown in image B.

7 - Install tiles as per tile's manufacture recommendation.

Note: When installing tiles below the tile manufacturers minimum recommended pitch, advice should be sought from the tile manufacturer in regard to fixing specification and/or any other aspects of installation.

For ventilation requirements, see page 20.

3.5 WARM ROOF

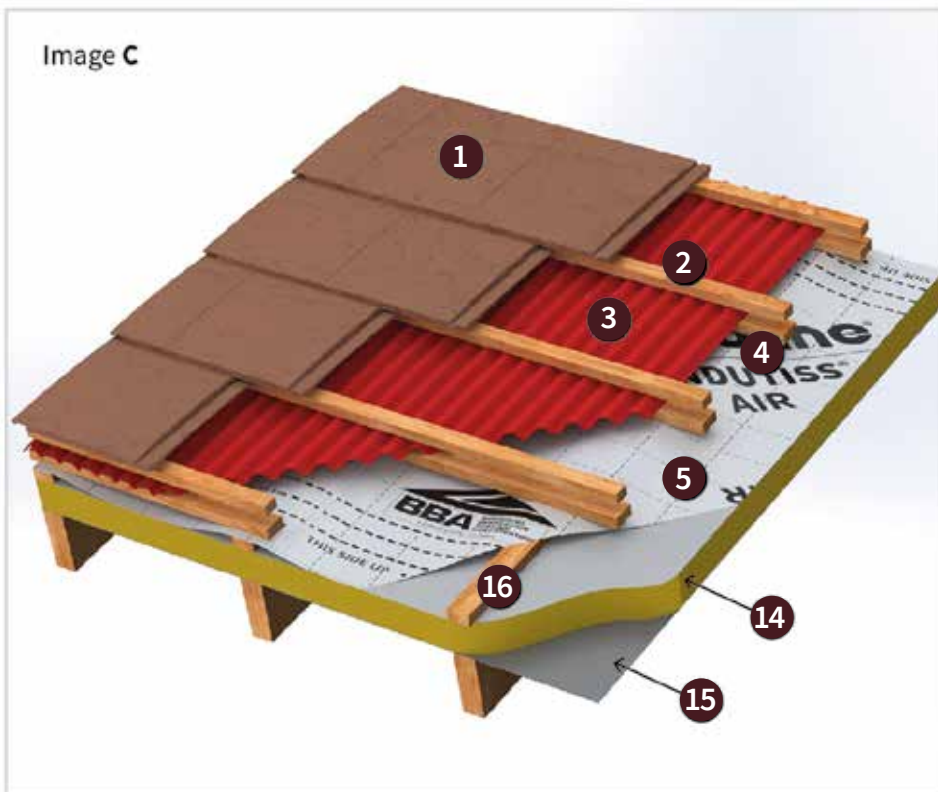

- 1 Roof Tiles
- 2 Tile Batten
- 3 ISOLINE® Sheet
- 4 Support Batten
- 5 Membrane

- 14 Insulation
- 15 Vapour Control Layer (VCL)
- 16 Counter Batten

WARM ROOF INSTALLATION STEPS

- 1 - In a warm roof configuration the installation steps are similar to Sections 3.1 and 3.2 of this document.
- 2 - Follow the correct installation steps to suit your roof structure.

Counter battens (16) must be minimum 50mm x 25mm.

Note: ISOLINE® LOW LINE sheets form a cold roof section. They do not form an integral part of a warm roof, are not vapour permeable and must be laid above the warm roof.

For ventilation requirements, see page 20.



**GUARANTEED
WATERPROOFING**

4. ROOF DETAILS

4.1 RIDGE AND HIP DETAIL

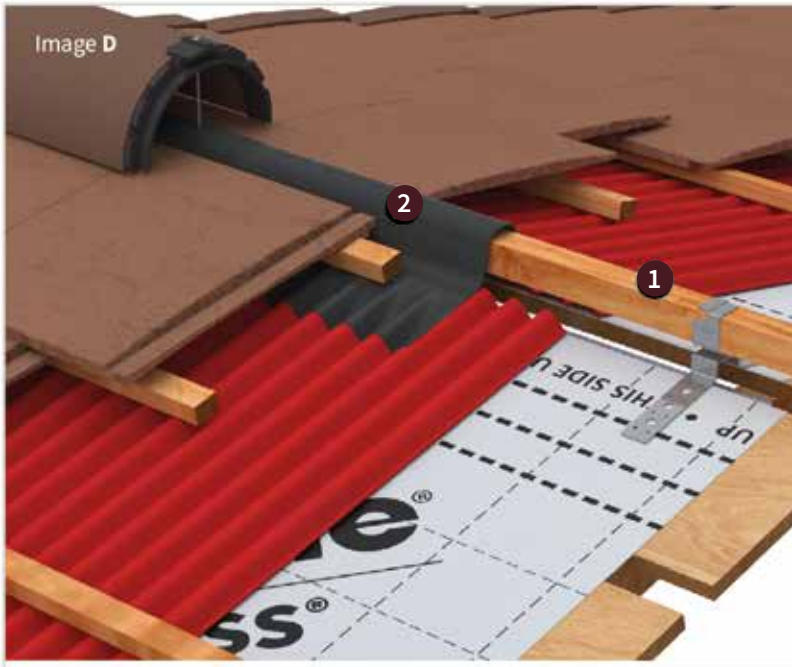

- 1 Ridge Batten
- 2 Ventilated Ridge Roll

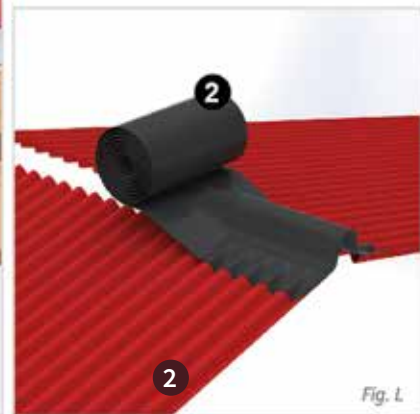

- At the ridge and hip lay **ONDUTISS® AIR** Membrane across the ridge/hip apex and dress down by overlapping a minimum of 300mm either side.
- If ridge ventilation is required, the membrane can be trimmed at ridge level to allow the flow of air (maximum 50mm gap). (refer to page 20)
- Lay the Ventilated Ridge Roll (2) on top of the ridge batten (1) and ensure overlapping of the Ridge Roll onto the **ISOLINE®** sheets by a minimum of 150mm either side.

4.2 WALL ABUTMENT

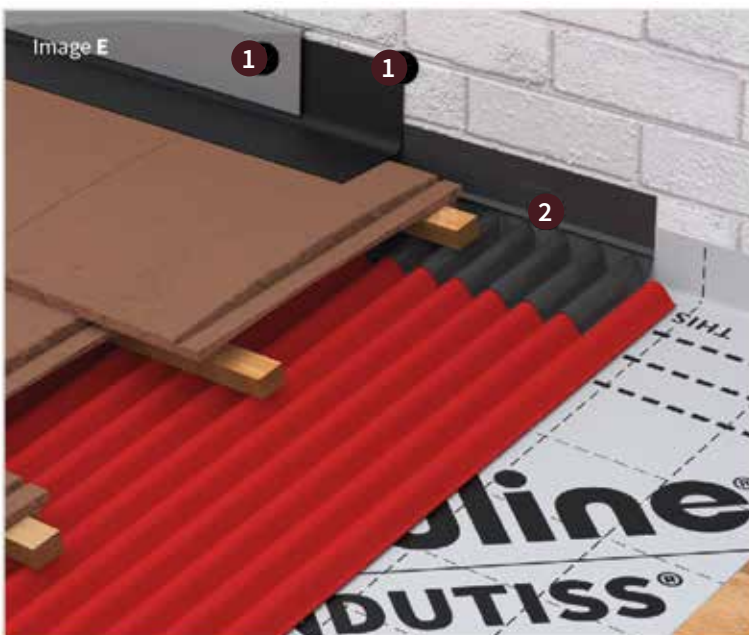

- 1 Flashing
- 2 Apron Flashing Piece

- For the end wall abutment, fold the roofing membrane upwards on to the wall (minimum 100mm). Install Onduline Apron Flashing Piece (2).
- The tile battens and tiles can then be fixed and a two-part flashing can be applied.
- Use wall abutment ventilators where ventilation is required.

4.3 SIDE WALL ABUTMENT

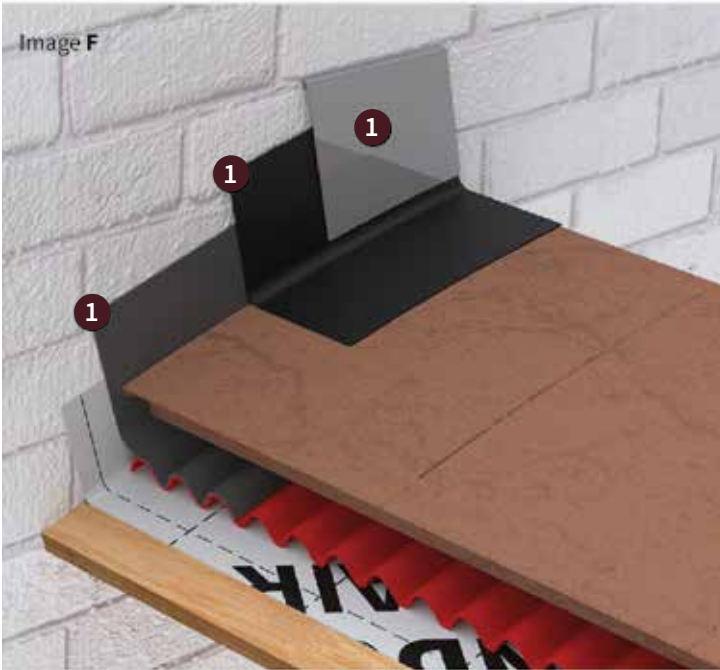

1 Flashing

- For side wall abutments use a conventional two to three layer flashing system (1) as shown in the image.

Note: the top-most flashing layer must be chased into the wall.

4.4 VALLEY DETAIL



- Ensure the underside of the valley area is covered with a layer of **ONDUTISS® AIR** Membrane. (minimum. 1000mm wide - 500mm each side)

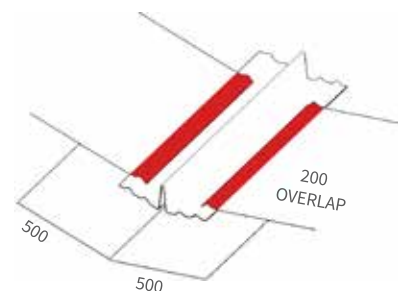

- Install the valley piece as per manufacturers' instructions.
- The second layer (roofing area membrane) must be overlapped by a minimum of 200mm into the valley piece either side (as shown in red above).
- Lay and cut the **ISOLINE® LOW LINE** sheets as shown in the picture on the right.

4.5 VENTILATION

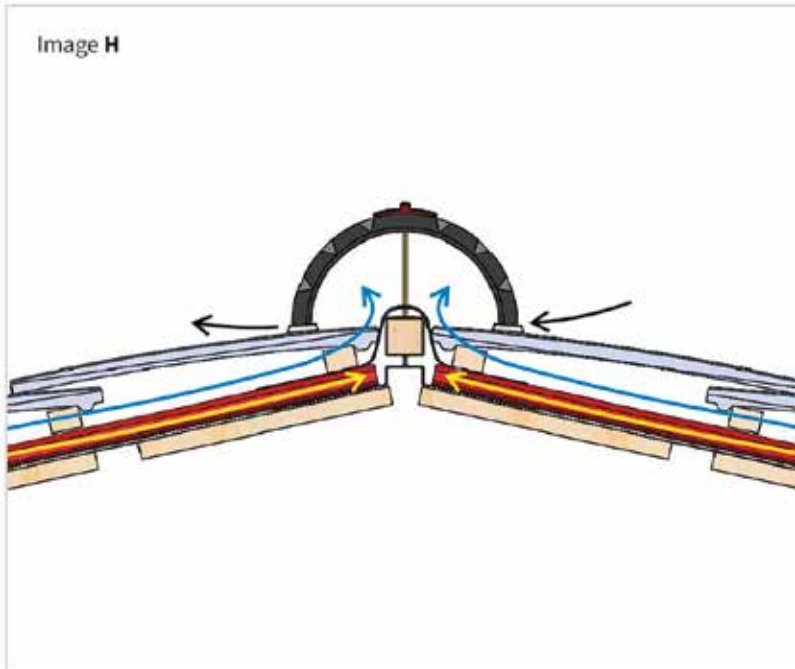

- 1 Ventilation above sheet
- 2 Ventilated below sheet

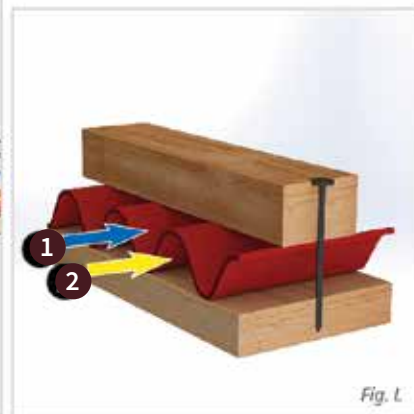

BEWARE OF THE RISKS OF CONDENSATION

- The **ISOLINE®** roof system forms a cold roof section and therefore ventilation is required below the sheets fully integrated with high and low roof tile ventilation provision.
- We recommend the use of **ONDUTISS® AIR** breathable membrane in all ISOLINE® applications.
- For more information and to understand the benefits of using a breathable membrane please see page 20.

All products mentioned in this document should be installed in accordance with the manufacturer's guidelines and where required, must be in line with:

- **BS 5534;** Slating and tiling for pitched roofs and vertical cladding - Code of practice
- **BS 5250;** Management of moisture in buildings - Code of practice

Installation must meet any law requirements of the country being installed in. Roof and ventilation design is by others. Roof may include products from a variety of manufacturers and their compatibility, alongside any legal compliance, must be ensured by the client direct.



4.6 PIPE/VENT PENETRATION

To create a watertight pipe or vent penetration, follow the below steps:

- Lay the sheets allowing a gap equal to the width of the pipe.
- Overlap the **ISOLINE®** sheets horizontally by aligning the embossed lines on the top sheet with the ones on the bottom sheet. This will provide approximately 220mm end lap coverage. For side overlaps use two corrugations (approximately 100mm).
- Overlay the **pipe flashing piece**, allowing an overlap of 150 mm between the flashing and the bottom sheet (for side overlaps, flashings must cover minimum two corrugations on both sides).
- Overlap the top **ISOLINE® sheet**, ensuring a minimum of 150 mm overlap between the flashing and the top sheet.

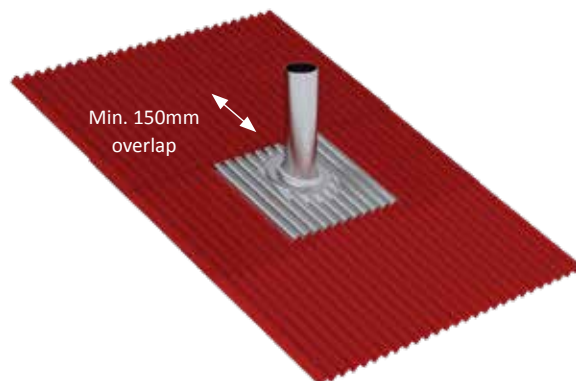
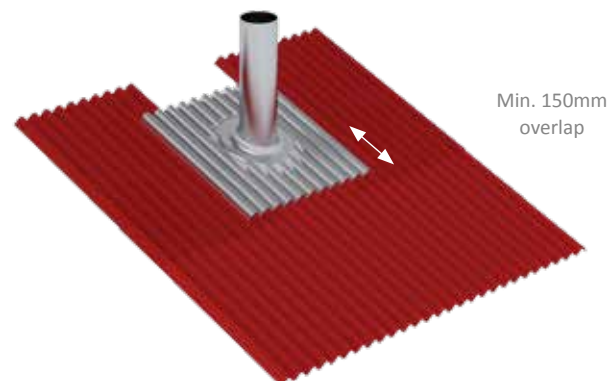
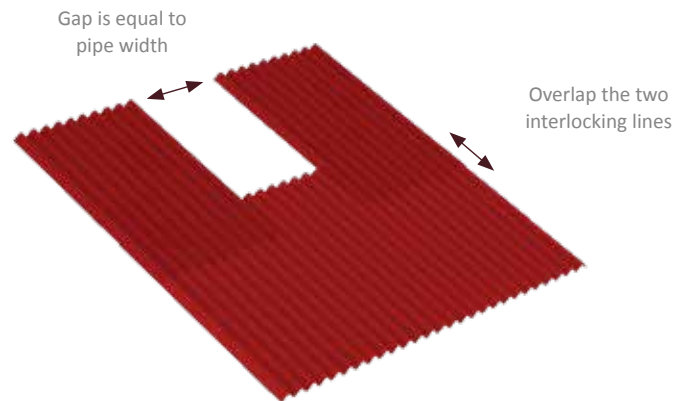

4.7 PHOTOVOLTAIC (PV) FIXINGS

To integrate solar panels in to the ISOLINE® LOW LINE roof structure, follow the below steps:

- Use **K2 Systems Hanger Bolt** fixing or similar.
- Bolts come in various lengths.
- Use a suitable length depending on the PV bracket and type of tile.

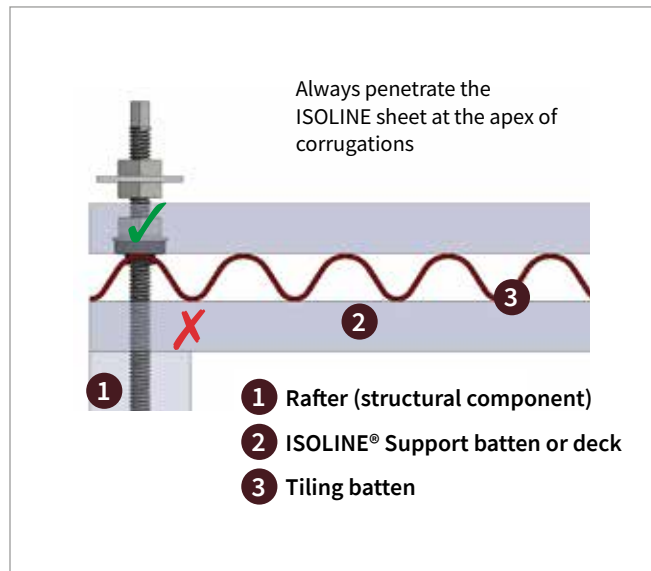
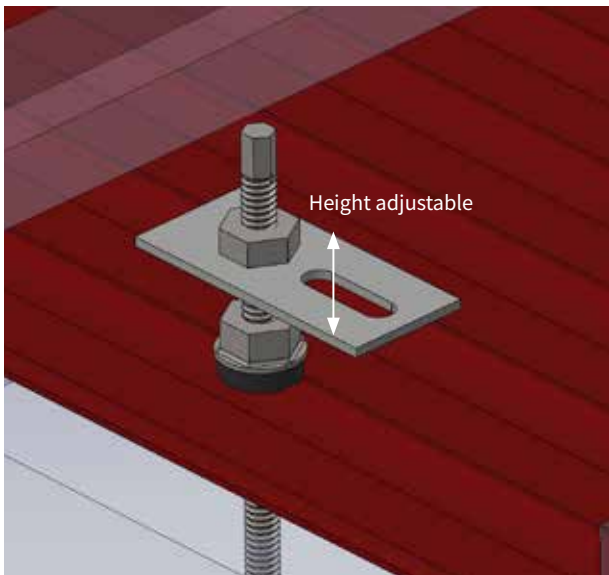
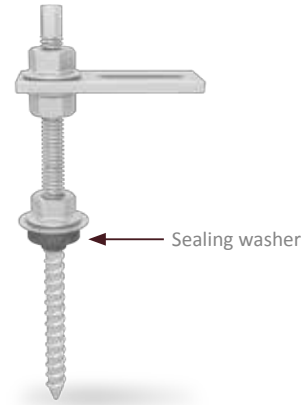

Screw in the bolt until the seal has made good contact with the **ISOLINE®** sheet.

- Do not over tighten or force the sheet corrugations to collapse.
- Only penetrate the **ISOLINE®** sheet at the top of the corrugations.
- Always fix structural components to rafters.
- If you need to fix where a rafter is not present, you must add a structural component (rafter or similar).

Note: When fixing solar panel brackets you must treat the **ISOLINE®** sheets as waterproofing components only, not as a structural component.

- Rafters will typically be the main structural components of a pitched roof.

IMPORTANT NOTE:

- This guide is for waterproofing purposes only.
- For structural considerations please consult a PV Specialist / Structural Engineer
- All fixings/brackets are by others.

5. ISOLINE® ACCESSORIES

ONDULINE® EAVES VENTILATOR STRIP

- The ventilator strip is fixed at the eaves to allow ventilation and to prevent the ingress of birds and rodents.

Length: 1000mm / Approximate coverage: 1000mm



ONDULINE® MULTI-PURPOSE EAVES TRAY

- Used underneath ONDULINE® and ISOLINE® sheets on an existing full deck roof to avoid the repositioning of the gutter. It also allows the reduction of the sheet overhang at the eaves.

Length: 1500mm / Approximate coverage: 1350mm (150mm overlap)



ONDULINE® BATTEN CLOAKING PIECE

- Used to protect the eaves batten from possible water ingress whilst also providing an aesthetically pleasing finish to the eaves detail.

**Length: 1220mm / Approximate coverage: 1120mm
55mm x 55mm for 25mm battens**



ONDULINE® APRON FLASHING

- ISOLINE® apron flashing is designed to seal the gap between ISOLINE® sheets and the vertical wall abutment.

**Length: 870mm / Approximate coverage: 770mm
(Two corrugations overlap)**



6. ROOF MEMBRANES

6.1 CONDENSATION CONTROL

It is a known fact that a considerable amount of a building's heat escapes through the roof and external walls. With increasing emphasis on the airtightness of the building envelope across the construction industry, the successful management of moisture and condensation within all types of structure is more critical now than it has ever been, and this is where breathable membranes come in to their own.

Onduline's ranges of **ONDUTISS®** membranes can help to control condensation of the roof. **ONDUTISS® AIR** multi-layer vapour permeable and waterproof membranes provide outstanding protection of the insulation layer against moisture, wind and condensation and should be installed with **ONDULINE®** roof sheets and **ISOLINE®** roof systems for guaranteed waterproofing.

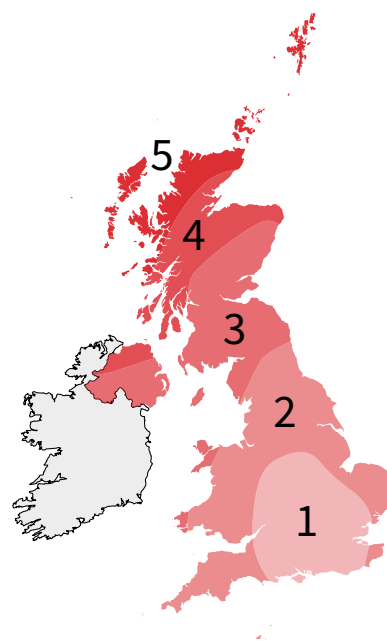

Zones 3 and 4 apply to Northern Ireland.
Zone 3 applies to Scilly Isles and Channel Islands.
Zone 5 applies to the Shetland Islands.

6.2 ONDUTISS® AIR MEMBRANES

	ONDUTISS® AIR (Breathable membrane)			
Range				
Description	Breathable, Flexible, Lightweight Polypropylene three layers			
Products	ONDUTISS® AIR 100	ONDUTISS® AIR 120	ONDUTISS® AIR 140	ONDUTISS® AIR 160
Weight	100 gsm	120 gsm	140 gsm	160 gsm
Dimensions	1 x 20 m / 1/1.5 x 50 m	1.5/1 x 50 m	1.5/1 x 50 m	1.5/1 x 50 m
Colour	Grey	Beige	Blue	Beige
Package	42 / 46 / 52 rolls	39 rolls	39 rolls	39 rolls
Water resistance	W1	W1	W1	W1
Wind zones				
≤345 mm batten gauge	Zones 1	Zones 1 to 2	Zones 1 to 3	Zones 1 to 5
≤250 mm batten gauge	Zones 1 to 5	Zones 1 to 5	Zones 1 to 5	Zones 1 to 5



7. SUSTAINABLE COMMITMENT

At Onduline®, our ongoing mission is to take serious sustainable actions at every level of our business, from our products and processes to our people and our planet. We're constantly striving to fundamentally improve the way we operate, providing our customers with truly sustainable roofing solutions at a reasonable price, improving people's lives as well as the neighbourhoods they live in.

WHAT ARE ONDULINE SHEETS MADE OF?

Onduline roofing and Underroofing sheets and tiles are composite sheets (with organic matrix) made of Bitumen, Recycled Cellulose fibres, Thermosetting Resin and Natural Pigments.

Recycled Cellulose fibres represent from 45 to 51% of the product content. (average : 50%). It is the same structure for all our bitumen solutions (sheets, tiles and accessories) whatever the application. Nevertheless, products are adapted in thickness, coating and shape to fit regional specifications, consumers specifications and climate conditions.

A SUSTAINABLE RAW MATERIAL

Cellulose is a non fossil raw material, meaning renewable resource, as it comes from plants and trees. It is easily recyclable, as Onduline uses in the production of bitumen sheets & tiles.

Cellulose transformation is known for its low carbon footprint, producing from 4 to 6 times lower CO₂ emissions than metal or plastic due to :

- Less transportation of raw material
- Less energy needed for transformation
- Less transformation steps in the process
- No consumption of fossil resources



OUR PROCESSES

We achieve a very low carbon footprint as well as low energy consumption in our manufacturing processes (4 kwh per m²). Our plants are equipped with high-performance treatment systems for gas effluents and emit no liquid. Waste in any form. Onduline has received a VAR Confirmation report (VAR 1016) by CC-ES to precise the recycled content of its solutions.





ISOLINE® LOW LINE



NEW BUILDS



RENOVATIONS

8. GENERAL INFORMATION

PRECAUTIONS ON ROOF USAGE

Roof traffic

Only walk on the roof if this is necessary. To distribute the load, planks or ladder should be laid flat and by the roof purlins to carry out maintenance and related work. All precautions should be taken and safety regulations must be observed and applied.

Roof maintenance

Maintenance of the roof is the responsibility of the owner. To ensure long life we recommend that the following maintenance procedures are carried out.

- Remove moss and debris. Do not allow leaf debris to build up on the surface of the corrugated roofing sheets, the debris will form leaf mould which can soften the material and reduce the effective life of the product.
- Check that branches are not in contact with the roof surface as wind generated movement can result in mechanical damage to the surface of the sheets.
- Clean all rainwater gutters, down-pipes and gullies regularly ensuring efficient water run-off from the roof.
- Maintain a good state of roof elements such as flashing, chimney stacks, etc.
- Maintain a good state of the roof and its ventilation.

SITE STORAGE

Onduline roofing and under roofing sheets are delivered to site on pallets of 150 to 420 sheets (depending on means of transport and sheet specification) shrink wrapped. It is not recommended to stack pallets. Sheets must be stored flat and covered at all times to protect against weather and dust. In hot climates Onduline sheets must be protected from direct sunlight.

HANDLING

Onduline roofing and under roofing sheets may be stored in freezing temperatures but installation should not be attempted in these conditions. The sheets should be lifted from the pallet, not dragged across it. The material should then be handled using conventional techniques for corrugated sheeting.

TECHNICAL SERVICES

Onduline provides a comprehensive technical and laboratory advice service for all applications of Onduline roofing systems. Please always refer to our specific technical guides for complete installation details and check with your representative, your local dealer or your specifier for your country building codes and regulations.

PRECAUTIONS

When using Onduline sheets in conditions of high internal humidity it is important to use a vapour barrier and adequate ventilation on the roof space.

CONDITIONS OF SALE

The colour impregnation is long lasting, but weathering effects cannot be entirely discounted and will affect Onduline roofing and under roofing sheets in the same way as they affect natural material roofs.

The Onduline Group assumes no responsibility for the effect of structural movement. Details are correct at the time of printing, but the manufacturers reserve the right to vary specifications and details at any time without notice. To avoid any possible misunderstandings, we require that a customer seeking advice on suitability or performance of goods or relating to the nature of services supplied should put such requirements to us in writing. Goods are not tested or sold as fit for any particular purpose unless so agreed in writing. There might be slight variations in size, weight and color.

GUARANTEE

The ISOLINE roof system is guaranteed to remain weatherproof for thirty years when fixed in strict accordance with the Onduline fixing instructions and maintained as directed. The guarantee is limited to the replacement cost of Onduline material only and does not extend to the primary tile / slate roof covering, labour, related construction or third party costs.



Onduline Building Products Ltd

150 Minorities,
London
EC3N 1LS

T. +44 (0)207 7270533
E. enquiries@onduline.net



www.onduline.co.uk

Onduline®
Lightweight roofing systems